

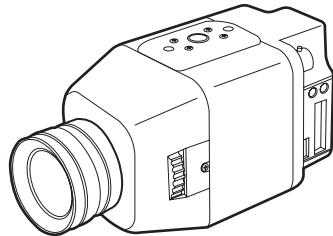

# Installation/Operation

**CC3700 Series  
Color Camera**

**C1986M-B (11/03)**





# CONTENTS

IMPORTANT SAFEGUARDS AND WARNINGS .....	4
Regulatory Notices .....	5
DESCRIPTION .....	5
Models .....	5
CAMERA LAYOUT .....	6
INSTALLATION .....	6
Lens Mounting .....	6
Camera Mounting .....	7
POWER AND VIDEO CONNECTIONS .....	8
LENS SETUP AND FOCUS PROCEDURES .....	10
BACK FOCUS ADJUSTMENT .....	11
SWITCH SETTINGS .....	12
CAMERA SYNCHRONIZATION .....	14
SPECIFICATIONS .....	15
WARRANTY AND RETURN INFORMATION .....	16

# LIST OF ILLUSTRATIONS

Figure 1. Camera Layout .....	6
Figure 2. AID/AIV Lens Connector .....	7
Figure 3. Camera Mounting .....	7
Figure 4. Power Supply Connections .....	8
Figure 5. AGC and ESC Switch Settings .....	10
Figure 6. Back Focus Adjustment .....	11
Figure 7. Switch Settings .....	12

# LIST OF TABLES

Table A. Recommended Wire Gauge and Wiring Distances .....	9
Table B. Video Coaxial Cable Requirements .....	9

## IMPORTANT SAFEGUARDS AND WARNINGS

Prior to installation and use of this product, the following WARNINGS should be observed.

1. Read these instructions.
2. Keep these instructions.
3. Heed all warnings.
4. Follow all instructions.
5. Do not use this apparatus near water.
6. Clean only with dry cloth.
7. Do not block any ventilation openings. Install in accordance with the manufacturer's instructions.
8. Do not install near any heat sources, such as radiators, heat registers, stoves, or other apparatus (including amplifiers) that produce heat.
9. Only use attachments/accessories specified by the manufacturer.
10. Use only with the cart, stand, tripod, bracket, or table specified by the manufacturer or sold with the apparatus. When a cart is used, use caution when moving the cart/apparatus combination to avoid injury from tip-over.
11. Refer all servicing to qualified service personnel. Servicing is required when the apparatus has been damaged in any way, such as power-supply cord or plug is damaged, liquid has been spilled or objects have fallen into the apparatus, the apparatus has been exposed to rain or moisture, the apparatus does not operate normally, or the apparatus has been dropped.
12. Apparatus shall not be exposed to dripping or splashing, and no objects filled with liquids, such as vases, shall be placed on the apparatus.
13. **Warning:** To reduce the risk of fire or electric shock, do not expose this apparatus to rain or moisture.
14. **Caution:** Danger of explosion if battery is replaced incorrectly. Replace only with the same or equivalent type.
15. To reduce the risk of shock, do not perform any servicing other than that contained in the operating instructions unless you are qualified to do so.
16. Use only installation methods and materials capable of supporting four times the maximum specified load.
17. Use only UL listed class 2 power supply.
18. **AID/AIV Lens Connector**  
**The maximum load for a direct drive lens must not exceed 25 mA.**  
**The maximum load for an auto-iris lens must not exceed 50 mA.**

The product and/or manual may bear the following marks:



This symbol indicates that dangerous voltage constituting a risk of electric shock is present within this unit.



This symbol indicates that there are important operating and maintenance instructions in the literature accompanying this unit.

<b>CAUTION:</b>
RISK OF ELECTRIC SHOCK. DO NOT OPEN.

Please thoroughly familiarize yourself with the information in this manual prior to installation and operation.

## REGULATORY NOTICES

This equipment has been tested and found to comply with the limits of a Class B digital device, pursuant to part 15 of the FCC rules. These limits are designed to provide reasonable protection against harmful interference in a residential installation. This equipment generates, uses, and can radiate radio frequency energy and, if not installed and used in accordance with the instructions, may cause harmful interference to radio communications. However there is no guarantee that the interference will not occur in a particular installation. If this equipment does cause harmful interference to radio or television reception, which can be determined by turning the equipment off and on, the user is encouraged to correct the interference by one or more of the following measures:

- Reorient or relocate the receiving antenna.
- Increase the separation between the equipment and the receiver.
- Connect the equipment into an outlet on a circuit different from that to which the receiver is connected.
- Consult the dealer or an experienced radio/TV technician for help.

Any changes or modifications not expressly approved by the party responsible for compliance could void the user's authority to operate the equipment.

This device complies with part 15 of the FCC Rules. Operation is subject to the following two conditions: (1) This device may not cause harmful interference, and (2) this device must accept any interference received, including interference that may cause undesired operation.

This Class B digital apparatus complies with Canadian ICES-003.

Cet appareil numérique de la classe B est conforme à la norme NMB-003 du Canada.

## DESCRIPTION

The CC3700 Series is a compact, color video camera with a 1/3-inch CCD imager. All cameras have a direct drive/auto iris lens connector and adjustable back focus, and they accept C and CS lenses.

### Models

CC3700S-2	Standard resolution, 330 TV lines, SuperHAD™ CCD, 0.5 lux @ 50 IRE, f1.2, NTSC
CC3700H-2	High resolution, 480 TV lines, SuperHAD™ CCD, 0.7 lux @ 50 IRE, f1.2 with 80% scene reflection, NTSC
CC3700S-2X	Standard resolution, 330 TV lines, SuperHAD™ CCD, 0.5 lux @ 50 IRE, f1.2, PAL
CC3700H-2X	High resolution, 480 TV lines, SuperHAD™ CCD, 0.7 lux @ 50 IRE, f1.2 with 80% scene reflection, PAL

## CAMERA LAYOUT

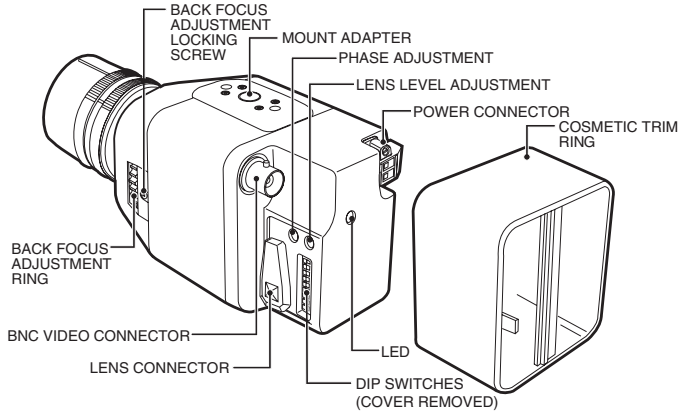

Figure 1. Camera Layout

**NOTE:** The cosmetic trim ring conceals the LED light for more discreet surveillance operations. The trim ring also hides the power connectors and protects the DIP switches.

## INSTALLATION

### Lens Mounting

The CC3700 Series camera can use fixed iris, manual iris, auto iris, or direct drive lenses. Cameras are factory-set for CS-mount lenses, but easily adjust for C-mount lenses.

1. **C-Mount Lens Only** - Loosen the two back focus locking screws. Rotate the back focus adjustment ring fully counterclockwise before installing the C-mount lens (refer to the section on *Back Focus Adjustment*).
2. Remove the cosmetic trim ring from the back of the camera (refer to Figure 1). Set the lens mode selector switch on the side of the camera to AIV (auto iris video drive lens) or AID (auto iris DC drive lens). Refer to the *Switch Settings* section. Switch setting is determined by the type of lens used.
3. Screw the lens onto the lens mount. Be careful to prevent dust from entering the space between the lens and the CCD element. If necessary, use clean, compressed air to remove any foreign matter.
4. Thread the lens cable through the cosmetic trim ring.
5. Connect the auto iris lens to the 4-pin iris drive connector located on the side of the camera. Pin connections for the iris drive connector are as follows.

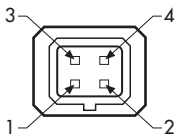

PIN	DC (AID) AUTO IRIS LENS	VIDEO (AIV) AUTO IRIS LENS
1	Control coil negative (-)	Lens positive supply
2	Control coil positive (+)	Not used
3	Drive coil positive (+)	Video drive signal
4	Drive coil negative (-)	Ground

Figure 2. AID/AIV Lens Connector

## Camera Mounting

Use a standard 1/4-20 screw (provided) with a maximum thread length of 3/8-inch (10 mm) for top or bottom camera mounting. The mount adapter may be fitted to the top or bottom of the camera. The camera is shipped with the mount adapter located on the top of the camera.

To change the mount adapter position:

- ❶ Remove the four screws from the mount adapter located on the top of the camera.
- ❷ Remove the trim cover from the bottom of the camera by prying it loose. Place the trim cover on the top of the camera where the mount adapter was removed. Press into place.
- ❸ Install the mount adapter to the bottom of the camera. Secure with the four screws removed in step 1.

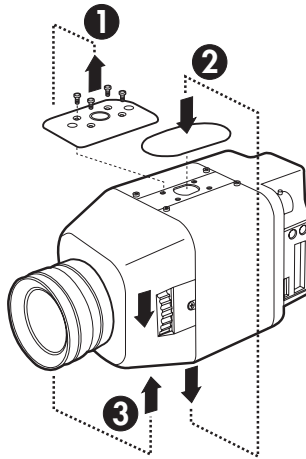
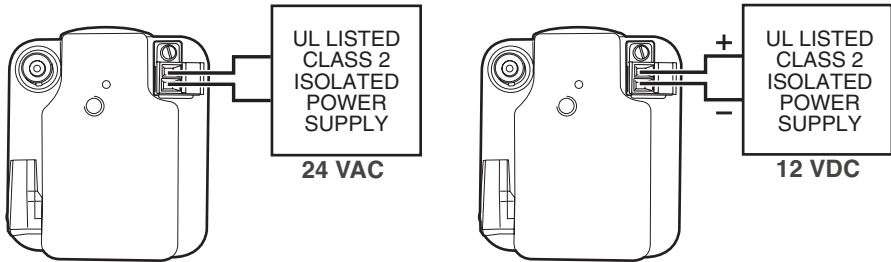

Figure 3. Camera Mounting

## POWER AND VIDEO CONNECTIONS

The CC3700 Series camera is designed to operate from a 12 VDC or 24 VAC power supply. The power supply connections are shown in Figure 4. The LED on the back panel of the camera indicates that power is connected. Use only a UL Listed Class 2 isolated power supply. Power consumption is less than 6.5 watts.



**Figure 4.** Power Supply Connections

To connect the camera power and video:

1. Remove the rear cosmetic trim ring from the camera (refer to Figure 1). Thread cabling through the trim ring.
2. Connect the power cable to the two-pin power connector on the back of the camera using the terminal block connector (provided). Refer to Table A for the recommended wire gauge and wiring distances.
3. Connect a video cable to the SIGNAL OUT connector (BNC) on the back of the camera. Refer to Table B for the type of video coaxial cable to use.
4. Reattach the trim ring to the back of the camera.



**AC Operation Only** – If you are wiring more than one camera to the same transformer, connect one side of the transformer to the same terminal on all cameras, and connect the other side of the transformer to the remaining terminal on all cameras. Failure to connect all of the cameras the same way will cause the cameras to be out of phase with each other and may produce a vertical roll when switching between cameras.

**Table A.** Recommended Wire Gauge and Wiring Distances

The following are the recommended maximum distances for 24 VAC applications and are calculated with a 10-percent voltage drop. (Ten percent is generally the maximum allowable voltage drop for AC-powered devices.)

**Wire Gauge**

<b>Total VA</b>	<b>20 (0.5 mm<sup>2</sup>)</b>	<b>18 (1.0 mm<sup>2</sup>)</b>	<b>16 (1.5 mm<sup>2</sup>)</b>	<b>14 (2.5 mm<sup>2</sup>)</b>	<b>12 (4.0 mm<sup>2</sup>)</b>	<b>10 (6.0 mm<sup>2</sup>)</b>
<b>10</b>	283 (86)	451 (137)	716 (218)	1142 (348)	1811 (551)	2880 (877)

**EXAMPLE:** A camera that requires 10 VA and is installed 283 feet (86 m) from the transformer would require a minimum wire gauge of 20 AWG.

**NOTE:** Distances are calculated in feet; values in parentheses are meters.

**Table B.** Video Coaxial Cable Requirements

<b>Cable Type*</b>	<b>Maximum Distance</b>
RG59/U	750 ft (229 m)
RG6/U	1,000 ft (305 m)
RG11/U	1,500 ft (457 m)

\* Minimum cable requirements:  
 75 ohms impedance  
 All-copper center conductor  
 All-copper braided shield with 95% braid coverage

# LENS SETUP AND FOCUS PROCEDURES

## Video Drive Auto Iris Lens

When a video drive auto iris lens is used, the lens mode selector switch must be set to AIV. Switch the ESC and AGC OFF. Refer to the lens instructions and adjust the lens for the optimum picture (video output level of 1V peak-to-peak). Switch the AGC ON. To focus, fully open the iris by covering the lens with a suitable neutral density (ND\*) filter. If the viewed scene is 6.5 feet (2 m) away or farther, set the lens focus to infinity (far). Use the back focus adjustment ring (refer to the *Back Focus Adjustment* section) and focus on the selected scene. Remove the ND filter and set the lens focus as required.

## Direct Drive (DC) Auto Iris Lens

When a direct drive lens is used, the lens mode selector switch must be set to AID. Switch the ESC and AGC OFF. Use an appropriate screwdriver to turn the lens level potentiometer (refer to Figure 1) fully clockwise. Next, slowly adjust the potentiometer counterclockwise until the optimum picture is obtained (video output level of 1V peak-to-peak). Switch the AGC ON. To focus, fully open the iris by covering the lens with a suitable neutral density (ND\*) filter. Select the scene to be viewed. If the viewed scene is 6.5 feet (2 m) away or farther, set the lens focus to infinity (far). Use the back focus adjustment ring (refer to the *Back Focus Adjustment* section) and focus on the selected scene. Remove the ND filter and set the lens focus as required.

## Fixed Lens

Set the ESC switch and AGC switch to ON. To focus, set the lens focus to infinity and view a scene greater than 6.5 feet (2 m) away. Focus the image with the back focus adjustment ring (refer to the *Back Focus Adjustment* section). Set the lens focus as required.

## Manual Iris Lens

Set the ESC switch and AGC switch to ON. To focus, open the iris fully and set the lens focus to infinity. View a scene greater than 6.5 feet (2 m) away. Focus the image with the back focus adjustment ring (refer to the *Back Focus Adjustment* section). Adjust the lens focus and set the iris for the best picture quality. The largest aperture gives the best light sensitivity, the smallest aperture the greatest depth of field.

## Zoom Lens

Set the lens focus to infinity (far) and fully open the iris by covering the lens with a suitable neutral density (ND\*) filter. Zoom out to the widest field of vision and view a distant object. Adjust the back focus adjustment ring until the object is in focus (refer to the *Back Focus Adjustment* section). Next, zoom fully in and adjust the lens focus until the object is again focused. Repeat these steps until the full zoom range may be viewed with the minimum loss of focus.



DIP SWITCH SETTINGS – WHITE REPRESENTS SWITCH POSITION

Figure 5. AGC and ESC Switch Settings

\***NOTE:** For best results outdoors use an ND3 filter.

## BACK FOCUS ADJUSTMENT

The back focus adjustment is located at the front of the camera and is accessible from either side of the case.

To adjust the back focus:

1. Loosen the two back focus locking screws (one on each side).
2. Turn the back focus ring:
  - a. Clockwise - Moves the CCD sensor assembly towards the back of the lens.
  - b. Counterclockwise - Moves the CCD sensor away from the back of the lens.
3. When the back focus adjustment is satisfactory, tighten the locking screws. Do not over-turn or force the back focus adjustment ring.

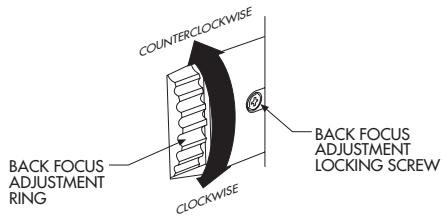

**Figure 6.** Back Focus Adjustment

# SWITCH SETTINGS

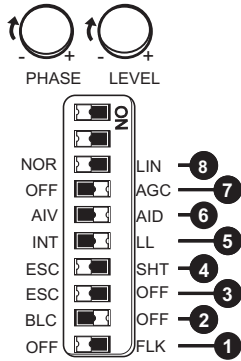

**NOTE:** White represents switch position.

Figure 7. Switch Settings (Defaults)

**NOTE:** Under most conditions, no setting of switches will be required. Please read the details of each switch before making any adjustments.

## Gamma (NOR/LIN Switch) - Switch Setting 8

Sets the Gamma level to one of the following:

- NOR** (Default setting) - Increases visibility in dark areas of the picture.
- LIN** - Linear response increases (overall) contrast.

- 8  NOR
- 8  LIN

## Automatic Gain Control (AGC/Off Switch) - Switch Setting 7

Automatically adjusts the image to compensate for changes in light levels when using fixed or manual iris lenses. Following are the AGC switch settings:

- ON** (Default setting) - Enables the AGC mode.
- OFF** - Disables the AGC mode.

- 7  AGC ON
- 7  AGC OFF

## Lens Mode Selector (AIV/AID Switch) - Switch Setting 6

The AIV/AID switch setting is determined by the type of lens used:

- AIV** - Video drive auto iris lens.
- AID** (Default setting) - Direct drive lens.

- 6  AIV
- 6  AID

## Synchronization (LL/INT Switch) - Switch Setting 5

Locks the frame rate to the power supply frequency. Eliminates vertical roll caused by multiple cameras connected to the same switching device. Each camera output is synchronized to the frequency of the power supply. Set the camera synchronization mode to one of the following:

- Line Lock (LL)** (Default setting) - Line-locks frame rate of cameras.
- Internal (INT)** - Disables line lock (use with DC power or noisy AC power).

- 5  LL
- 5  INT

## Shutter Speed Selection - Switch Settings 4, 3, 2, and 1

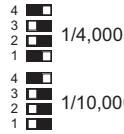
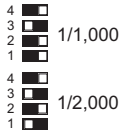
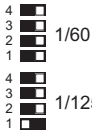

00014

### ESC (Electronic Sensitivity Control) Switch Settings 4, 3, and 1

The ESC feature compensates for an excessive light level by automatically adjusting shutter speed. Following are the ESC switch settings:

**ESC** (Default setting) - Enables the Electronic Sensitivity Control mode.

**OFF** - Disables the Electronic Sensitivity Control mode.



### BLC (Backlight Compensation) Switch Settings 4, 2, and 1

The BLC (Backlight Compensation) feature compensates for backlit scenes by enhancing objects in the center of the scene that would previously have been in silhouette. BLC will only function with a manual iris lens when the Electronic Sensitivity Control feature is switched on. For direct drive and auto iris lenses, BLC will still function even though the Electronic Sensitivity Control feature is switched off. Following are the BLC switch settings:

**BLC** - Enables the BLC mode.

**OFF** (Default setting) - Disables the BLC mode.



### Flickerless Switch Settings 4, 3, and 1

The Flickerless setting can reduce the flicker caused by certain lighting conditions. The Electronic Sensitivity Control setting must be off for correct operation of the Flickerless function. Choose between the following settings:

**FLK** - Enables the Flickerless mode.

**OFF** (Default setting) - Disables the Flickerless mode.



## **CAMERA SYNCHRONIZATION**

When using more than one camera power supply, a brief vertical roll may occur on the monitor when a camera view is switched. To eliminate vertical roll, adjust the phase control by synchronizing, or line-locking, the cameras to one another. Set the INT/LL DIP switch to LL and use the phase potentiometer located on the side of the camera (refer to Figure 1) to make adjustments.

It may be necessary to have two people in communication when synchronizing the cameras: one person at the camera and another person at the monitor to observe the vertical roll and the effect of any adjustments made at the camera.

To synchronize the cameras do the following:

1. Choose a reference camera to which all other cameras will be phased.
2. Select a camera and synchronize it to the reference camera by turning the phase adjustment control clockwise and/or counterclockwise.
3. Each time an adjustment is made, switch back and forth between the camera you are adjusting and the reference camera. Repeat this process as many times as necessary, until the roll between the cameras is no longer noticeable.
4. Adjust the phase of all other cameras by repeating steps 2 through 3. Always adjust to the reference camera selected in step 1.

**NOTE:** The preferred method for camera phase adjustment is to use a dual trace oscilloscope to align the vertical sync pulses of the reference camera to the selected camera(s).

# **SPECIFICATIONS**

## **GENERAL**

CCD Sensor:	1/3-inch
Picture Elements	
CC3700S-2:	510 (H) x 492 (V)
CC3700H-2:	768 (H) x 494 (V)
Sensing Area:	6mm diagonal
Synchronization System:	AC line lock or internal oscillator
Horizontal Resolution	
CC3700S-2, CC3700S-2X:	330 TV lines
CC3700H-2, CC3700H-2X:	480 TV Lines
Iris Control:	Electronic/passive
Minimum Illumination	
CC3700S-2, CC3700S-2X:	0.5 lux at 50 IRE, f1.2 with 80% scene reflection
CC3700H-2, CC3700H-2X:	0.7 lux at 50 IRE, f1.2 with 80% scene reflection
Signal-to-Noise Ratio:	52 dB (AGC Off)
Gain Control:	Automatic
Vertical Phase:	Adjustable 0° ±120°
Automatic Gain Control:	Selectable by DIP switch setting
Backlight Compensation:	Selectable by DIP switch setting
Scanning System:	525 lines, 2:1 interlace
Signal Processing:	DSP
Auto Iris Lens Type:	DC/video control
Video Output:	1 Vp-p, 75 ohms
Iris Control Range:	1/60 to 1/100,000 second
Auto White Balance Range:	2500-9500° K

## **ELECTRICAL**

Power Requirements:	11-40 VDC or 14-30 VAC
Power Consumption:	Less than 6.5 watts
Power Connector:	2-pin terminal strip, push-in type, with screw lock
Video Connector:	BNC
Lens Jack:	4-pin connector (miniature square)

## **MECHANICAL**

Lens Mount:	C/CS mount (adjustable)
Camera Mount:	Use 1/4-20 screw, top or bottom of camera housing

## **ENVIRONMENTAL**

Operating Temperature:	14° to 122°F (-10° to 50°C)
Storage Temperature:	14° to 158°F (-10° to 70°C)

## **PHYSICAL**

Physical Dimensions:	2.48 (W) x 2.67 (H) x 4.33 (D) inches (6.3 x 6.8 x 11 cm)
Weight (without lens):	0.77 lb (0.35 kg)

(Design and product specifications subject to change without notice.)

# WARRANTY AND RETURN INFORMATION

## WARRANTY

Pelco will repair or replace, without charge, any merchandise proved defective in material or workmanship for a period of one year after the date of shipment. Exceptions to this warranty are as noted below:

- Five years on Pelco manufactured cameras (CC3500/CC3600/CC3700 and MC3500/MC3600 Series); two years on all other cameras.
- Three years on Genex® Series (multiplexers, server, and keyboard) and 090 Series Camclosure® Camera System.
- Two years on 100/150, 200 and 300 Series Camclosure® Camera Systems.
- Two years on all standard motorized or fixed focal length lenses.
- Two years on Legacy®, CM6700/CM6800/CM8500/CM9500/CM9740/CM9760 Matrix, DF5 and DF8 Series Fixed Dome products.
- Two years on Spectra®, Esprit®, and PS20 Scanners, including when used in continuous motion applications.
- Two years on Esprit and WW5700 series window wiper (excluding wiper blades).
- Eighteen months on DX Series digital video recorders.
- One year (except video heads) on video cassette recorders (VCRs). Video heads will be covered for a period of six months.
- Six months on all pan and tilts, scanners or preset lenses used in continuous motion applications (that is, preset scan, tour and auto scan modes).

Pelco will warrant all replacement parts and repairs for 90 days from the date of Pelco shipment. All goods requiring warranty repair shall be sent freight prepaid to Pelco, Clovis, California. Repairs made necessary by reason of misuse, alteration, normal wear, or accident are not covered under this warranty.

Pelco assumes no risk and shall be subject to no liability for damages or loss resulting from the specific use or application made of the Products. Pelco's liability for any claim, whether based on breach of contract, negligence, infringement of any rights of any party or product liability, relating to the Products shall not exceed the price paid by the Dealer to Pelco for such Products. In no event will Pelco be liable for any special, incidental or consequential damages (including loss of use, loss of profit and claims of third parties) however caused, whether by the negligence of Pelco or otherwise.

The above warranty provides the Dealer with specific legal rights. The Dealer may also have additional rights, which are subject to variation from state to state.

If a warranty repair is required, the Dealer must contact Pelco at (800) 289-9100 or (559) 292-1981 to obtain a Repair Authorization number (RA), and provide the following information:

1. Model and serial number
2. Date of shipment, P.O. number, Sales Order number, or Pelco invoice number
3. Details of the defect or problem

If there is a dispute regarding the warranty of a product which does not fall under the warranty conditions stated above, please include a written explanation with the product when returned.

Method of return shipment shall be the same or equal to the method by which the item was received by Pelco.

## RETURNS

In order to expedite parts returned to the factory for repair or credit, please call the factory at (800) 289-9100 or (559) 292-1981 to obtain an authorization number (CA number if returned for credit, and RA number if returned for repair).

All merchandise returned for credit may be subject to a 20% restocking and refurbishing charge.

Goods returned for repair or credit should be clearly identified with the assigned CA or RA number and freight should be prepaid. Ship to the appropriate address below.

*If you are located within the continental U.S., Alaska, Hawaii or Puerto Rico:*

Service Department  
Pelco  
3500 Pelco Way  
Clovis, CA 93612-5699

*If you are located outside the continental U.S., Alaska, Hawaii or Puerto Rico:*

**Intermediate Consignee**  
American Overseas Air Freight  
320 Beach Road  
Burlingame, CA 94010  
USA

**Ultimate Consignee**  
Pelco  
3500 Pelco Way  
Clovis, CA 93612-5699  
USA

© Pelco, the Pelco logo, Spectra, Genex, Legacy, Esprit, and Camclosure are registered trademarks of Pelco.  
™ HyperHAD and EXview HAD CCD are trademarks of the Sony Corporation.  
© Copyright 2002, Pelco. All rights reserved.

## REVISION HISTORY

Manual #	Date	Comments
C1986M	3/02	Original version.
C1986M-A	7/02	Revised the lens connector wiring chart.
C1986M-B	8/02	Revised <i>Important Safeguards and Warnings</i> .
	11/03	Revised instructions for setting DIP switches to match Baxall version of manual.